

SECTION A-A

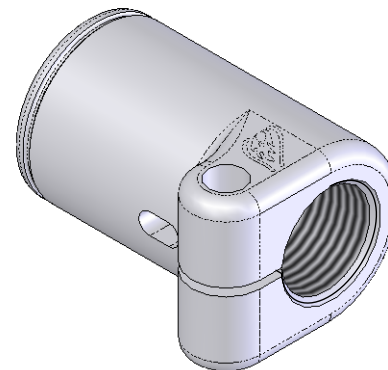

Specialty Products Company
 Longmont, Colorado USA • www.specprod.com

LINEAR mm[in]	ANGLE (deg.)
None±1.00 [X ±.040"]	None± 2.0°
.X ±0.50 [XX ±.020"]	.X ± 1.0°
.XX ±0.25 [XXX±.010"]	.XX ± 0.5°

CONFORMS TO
 ASME Y14.5

15095

MATERIAL: 4140 PER SAE ASTM A 331
 FINISH: None